

**Glider Flight Manual GROB G 102 Standard Astir III Factory Serial Number 5556S
N123KG AS**

Scanned and formatted by Russ Husted, CFGI, r.husted@cwix.com

Please read the original manual prior to flight as I will not be responsible for any inaccuracies in the scanning or formatting process. I hope you enjoy this manual as much as flying "AS". Safe Soaring!

1.5. Three-side view

October 1982

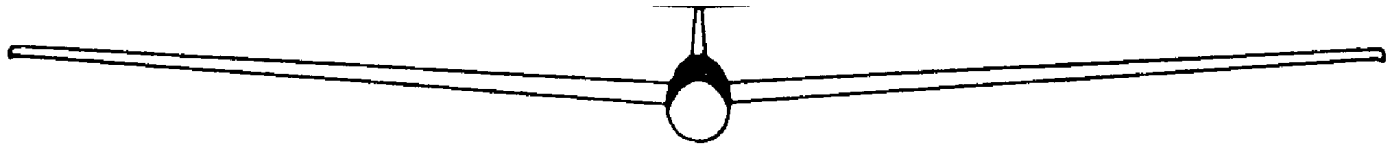

RUMPF DER CLUB ASTIR III



RUMPF DER STANDARD ASTIR III
(EINZELFAHRWERK)

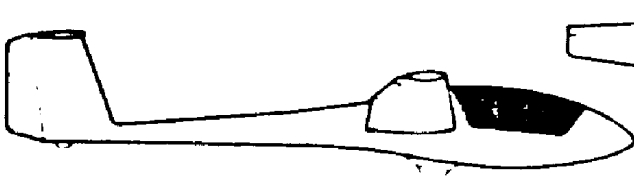

RUMPF DER CLUB ASTIR III b

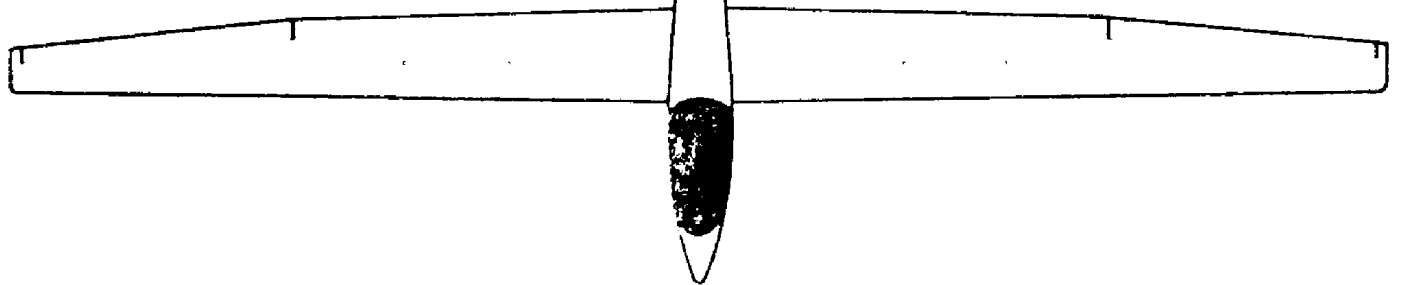

1.3. Contents	Page
I. General	(Omitted)
I.1. Log of revisions	Dec 1982
I.3. Contents	2,3
I.4. Total view (photo)	(Omitted)
I.5. Three-side view	Front piece
I.6. Description	6
II. Operating limits	7
II.1 Category of airworthiness	7
II.2 Permitted operations	7
II.3 Minimum equipment	7
II.4 Airspeed limitations	7,8.9
II.5 Flight envelope	9
II.6 Weights	9
II.7 Center of gravity position	9,10
II.8 Loading limitations, weighing report	10,10a,11-EMPTY
II.9 Tow hooks	12
II.10 Weak link in launching cable	12
II.11 Tire pressure	12
II.12 Crosswinds	12
II.13 Placards and markings	13-18
III. EMERGENCY procedures	19
III.1 Spin recovery	19
III.2 Canopy jettison and exit	19
III.3 Landing with undercarriage retracted	20
III.4 Miscellaneous (Rain, wing dropping, ground looping)	20

	Page	
IV.	Normal procedures	21
IV.1	Cockpit and control layout	21,22
IV.2	Daily inspection	23,24,25
IV.3	Pre flight check	26
IV.4	Take off	26,27
IV.5	Normal flight	27
IV.6	Slow flying and stalling	28
IV.7	High speed flight	28
IV.8	Simple aerobatics	29
IV.4	Approach and landing	30
IV.10	Flying with waterballast	31,32
IV.11	Storage	33
V.	Performance	33
V.1 .	Flight Polar	34
VI.	Rigging and derigging	35
VI.1	Rigging	35,36,37
VI.2	Derigging	37
VI.3	Transport	38
VI.4	Simple Maintenance	38,39
VII.	Measurement of centre of gravity	40,41,42

October 1982

1.6. Description

The CLUB ASTIR III and IIIb a single seat performance glider for the club class with a T-tail and airbrakes on the upper wing surface. The STANDARD ASTIR III is the equivalent high performance glider for the standard class, with retracting undercarriage and ballast tanks in the wings. The glider incorporates the most modern fibre reinforced plastic technology. The fuselage stringers are fabricated from Carbon fibre; all other surfaces and shells are glassfibre,

Technical Data

Wingspan	15,0 m	(49,2 ft)
Length	6,75 m	(2291 ft)
Height	1,26 m	('4,1 ft)
Aspect ratio	1892	(18,2)
Wing area	12,4 m ²	(133,5 sq.ft.)
Maximum flying weight with waterballast	450 kg	(992 lbs)
without waterballast	380 kg	(838 lbs)
Maximum wing loading	36,3 kg/m ²	(7,4 lbs/sq.ft)

December 6, 1982

Approved by LBA

II. operating limitations

II.1 Category of airworthiness:

U (Utility) according to JAR 22

Certification Basis: 14 CFR Sections 21.23 and 21.29 effective 1 February 1965; and Joint Airworthiness Requirements for Sailplanes and Powered Sailplanes (JAR-22), dated 1 April 1980.

II.2 Permitted operations:

- 1. VFR day
 - 2. *Simple aerobatics (loop, stall turn, lazy eight, chandelle, spin)
- *NOTE: ASA does not permit aerobatics in club ships

II.3 Minimum equipment

- 1. Air speed indicator reading to 300 km/h (162 knots, 187mph)
- 2. Altimeter
- 3. Four part safety harness
- 4. Back cushion of at least 3" depth when compressed, or parachute
- 5. Loading limit placard
- 6. Flight limits placard
- 7. Flight Manual

II.4 Airspeed limitations

Never exceed	VNE 250 km/h(135 kts,155mph)
Maximum Rough Air	VB 250 km/h(135 kts,155mph)
Manoeuvring speed	VM 170 km/h(92 kts,105mph)
Maximum on winch launch	VW 120 km/h(65 kts, 74mph)
Maximum on aerotow	VT 170 km/h(92 kts,105mph)
Maximum for operating landing gear, and L.G. extended	VT 250 km/h(135 kts,155mph)

"Rough air" includes the turbulence likely to be encountered in wave rotors, clouds, whirlwinds, and while flying over mountain ridges.

The manoeuvring speed is the maximum speed at which full control deflections are permissible. At VNE only one third of the available movements may be used. True airspeed is higher than indicated airspeed at altitude.

This fact has no influence on the strength and the aerodynamic loads on the sailplane. But for flutter prevention VNE must be decreased according to the following table.

Altitude (ft)	0-6500	10000	13000	16500	19000
VNE (indicated knots)	135	128	121	115	109
(indicated km/h)	250	237	225	213	202

Air speed indicator markings

72-170 km/h	39-92 kts	45-106mph	Green arc (normal range)
170-250 km/h	92-135 kts	106-155mph	Yellow arc (caution range)
At 250 km/h	135 kts	155 mph	Red line (max. speed)
At 90 km/h	49 kts	56 mph	Yellow triangle (minimum approach speed at max. flying weight)

Installation Errors of ASI The airspeed indicator must be connected to the following sources: Pitot head in the tail fin, static vents side of the fuselage near the seat, Using a calibrated ASI the position error is not greater than + 2 km/h or 1 kt or 1,2 mph. A calibration curve is therefore not necessary.

II.5 Flight envelope

The following g-loads must not be exceeded.

At VM + 5.3 - 2.65
 At VNE + 4.0 - 1.5
 (Airbrakes closed)

II.6 Weight limits

Empty weight	appr. 260 kg	(573 lbs)
Max. permissible without waterballast	380 kg	(638 lbs)
Max. permissible with waterballast	450 kg	(992 lbs)

Maximum permissible weight
of non lifting parts 250 kg (551 lbs)

II.7 Center of gravity position

Permitted center of gravity positions in flight lie in the range:

from 310 mm (12,20 inches) to 480 mm (18,90 inches)

behind the datum line, equivalent to 24% to 44% of the M.A.C. of the wing.

December 6, 1982

Approved by LBA

A/c attitude: incidence board of 600:26 angle horizontal on the back of the fuselage.

The datum line is the wing root leading edge.

The permitted center of gravity range will not be exceeded if the loading is carried out according to the loading plan in section 11.8.

II.8 Loading limitations

Minimum weight in the seat	70 kg	(154 lbs)
Maximum weight in the luggage space	10 kg	22 lbs)

Maximum weight in the seat 110 kg (242 lbs)

Pilot weights lower than 70 kg (153 lbs) must be compensated by ballast carried in the seat.

The maximum flying weight of 380 kg (838 lbs) without waterballast and of 450 kg (992 lbs) with waterballast must not be exceeded. Water ballast can only be loaded until this maximum weight is reached (see diagram on side 10a).

Water ballast can not be used to compensate locking weight in the seat.

December 6, 1982

Approved by LBA

Waterballast chart (only Standard Astir III)

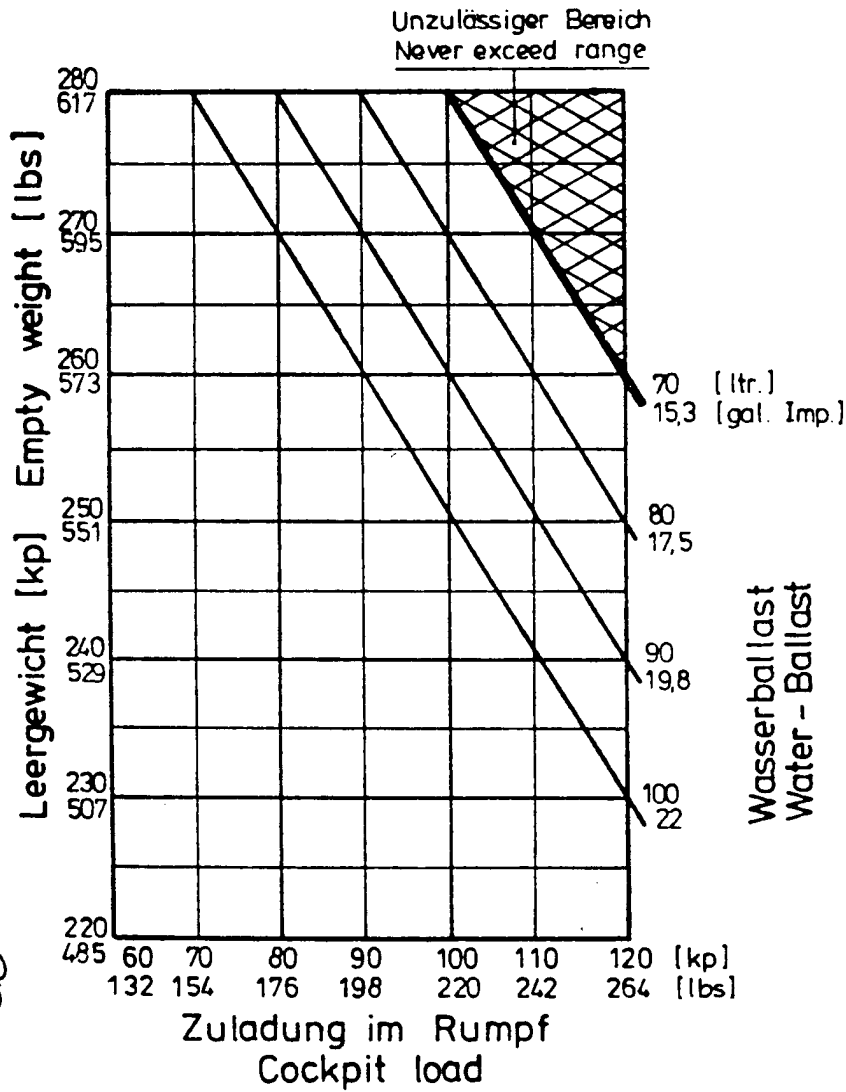

(einschließlich Gepäck; Baggage inclusive and ballast in ballast box)

Tanks max cap 50 Ltr's each

December 6, 1982

Approved by LBA

II.9 Tow hooks and cable length

For Aerotow: Optional nose hook E 75 with
modification 1-79

For Aerotow and winch launch: Europa G 73 safety hook.

Minimum aerotow cable length 40 m (130 ft)

Minimum launch cable length 600 m (1970 ft)

II.10 Weak link in launching cable

Aerotow and winch launch 500 kg (1100 lbs)+/-10%
(e.g. Weak link no. 5. color code white)

II.11 Tire pressure

Tire size Main wheel 5.00-5 / Tire pressure 2.5 bar

Nose wheel and Tail wheel 0 210 x 65 mm. 2,5 bar

11.12 Crosswinds

The maximum approved crosswind component for take off and landing is 11 knots
(12 mph).

December 6, 1982

Approved by LBA

11.13 Placards and markings

Maximum weight	kg	lbs
Without water ballast:	380	836
with water ballast:*	450	990

Airspeed limits	k m/h	<u>m.p.h.</u>	fts
Never exceed	250	155	135
In rough air	250	155	135
Manoeuvring	170	105	92
On aerotow	170	105	92
On winch tow	120	74	64
Airbrakes	250	155	135
Gear extension	250	155	135

cockpit *(no valid for CLUB ASTIR III and IIIb)

Payload

Payload (pilot and parachute) The maximum weight must not be exceeded.

Minimum payload: 70 kg, 154 lbs. Less weight must be compensated with ballast in the seat or in the ballast box

Maximum load 110 kg 243 lbs

The maximum weight must not be exceeded.

cockpit

December 6, 1982

Approved by LBA

Check before launch

- Wing and tailplane connections checked?
- Full and free movement of controls?
- Parachute secured?
- Straps tight and locked?
- Pedals adjusted and locked?
- Brakes closed and locked?
- Trim correctly adjusted?
- Altimeter adjusted?
- Canopy locked?
- Cable on correct hook?

Beware: – Crosswind! – Cable break!

cockpit

Simple aerobatics manoeuvres

Recommended entry speed	km/hr	knots	mph
Loop	180	97	112
Stall turn	180	97	112
Chandelle	150	81	93
Lazy eight	120	65	75
Spins	--	--	--

Aerobatics with waterballast is not allowed.

Cockpit

TIRE: 2,5 bar (36psi)

Nose and Tail wheel cover

Weak links for towing
500 kp, 1100 lbs. max.
Tire: 2,5 bar 36 psi.

Main wheel cover

Altitude(ft)	0-6500	10000	13000	16500	19000
VNE (KIAS)	135	128	121	115	109

near airspeed indicator

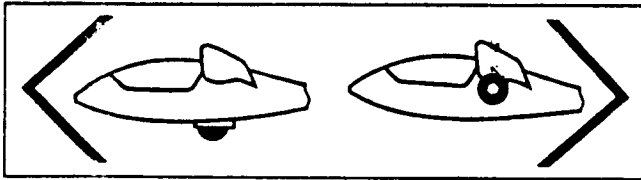

Undercarriage lever (only Stand. Astir III)

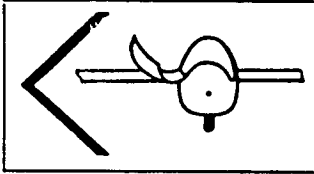

Left

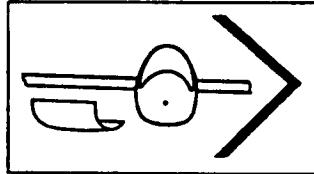

Canopy catch
Right side

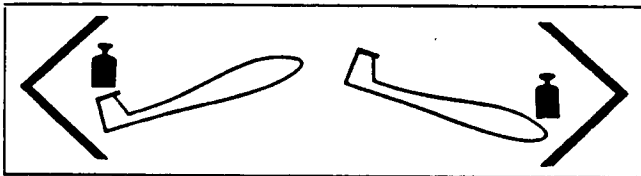

Trimmer green lever (left side of fuselage)

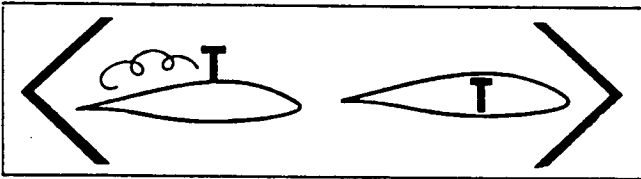

Airbrake lever

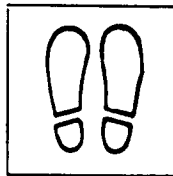

Rudder pedal adjustment (Instrument panel)

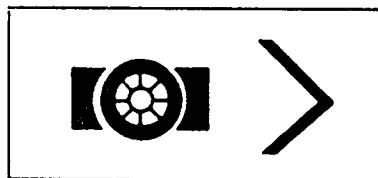

Wheel brake (Airbrake lever)

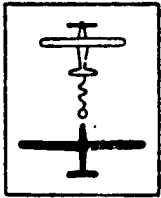

Baggage maximum
22 lbs 10 kg

(luggage compartment)

Cable Release
(Instrument panel)



Ventilation
(Instrument panel)

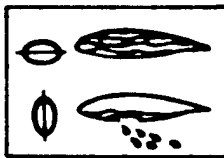

Water ballast jettison
(Instrument panel)
(Standard Astir III)

Don't push or
lift here

Fin
(both sides)

Elevator quick lock connected
Markings notice
Rotating knob turned in
Tailplane secured (cover closed)

Tailplane
checklist
(Fin)

For	N	80	60	E	120	180
Steer						
For	S	210	240	W	300	330
Steer						
DATE						

near magnetic
direction indicator

December 6, 1982

Approved by LBA

Number of ballast weights		
Weight of pilot (parachute incl.)	55-69,9 kg	70-110 kg
Number of weights	1	0
1 ballast weight: 8,6 kg		

cockpit

Labels and Markings outside of the fuselage

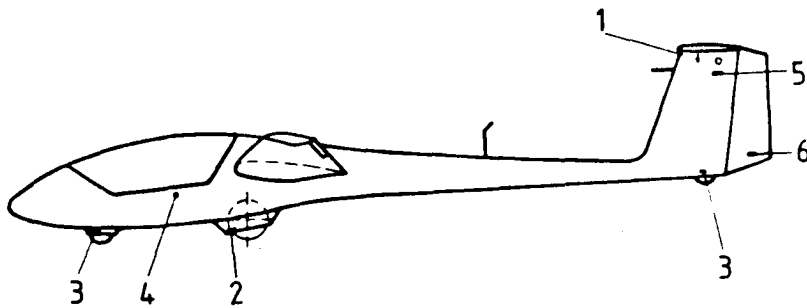

- 1 Control Markings for the correct rigging of the tailplane
- 2 Label of Tire pressure and weak link strength
- 3 Label of Tire pressure
- 4 Red rings around static pressure port
- 5 Placard for elevator fastening
- 6 "Don't push or lift here"

December 6, 1982

Approved by LBA

Air Speed Indicator Markings

km/h	knots	mph	Marking	Significance
72-170	39-92	45-105	Green arc	Normal range of flying speed
170-250	92-135	105-155	Yellow arc	Range of flying speeds to be used with care
250	135	155	Radial Red line	Maximum speed (VNE)
90	49	56	Yellow triangle	Minimum recommended landing speed at maximum all up weight

72 km/h(39 kts/45 mph) = $V_s 1,1$ under max. flight weight conditions



December 6, 1982

Approved by LBA

III. EMERGENCY PROCEDURES

III.1 Spin recovery

Exit from spin can be accomplished by the standard recovery procedure:

- Full opposite Rudder
- Neutralize stick
- Ailerons should be neutral
- when rotation stops neutralize rudder and pull out gently.

III.2 Canopy jettison and exit

The freedom of movement in the cockpit makes exit easy in an emergency. The point to fix the parachute is the red ring on the central tube behind the seatback.

- a) Pull red knob back on the left and disengage the pin.
- b) Pull red knob back on the right and with the left hand push canopy upwards.
- c) Unbuckle seat harness.
- d) EXIT over left or right side.
- e) Wait only 1-3 seconds before pulling the rip cord.

December 6, '1982

Approved by LBA

III.3 Landing with the undercarriage retracted (only STANDARD ASTIR III)

It is possible to land on soft and hard surface without risk of nosing over. Approach normally and align in 2 point attitude. Avoid a high roundout.

III.4 Miscellaneous

Flying in rain

There is a noticeable deterioration of flying characteristics by wet or lightly iced wings, which raises the stall speed by about 5 km/h (3 knots). Increase take off and approach speed by 6 knots.

Wing dropping

If the wing drops in a turn or straight flight, leave the stick neutral and apply rudder against the direction of rotation.

Ground looping

The aircraft is not prone to ground loop on take off. However if one wing touches the ground or the aircraft changes direction by more than 15 degrees during take off release tow cable immediately.

December 6, 1982

Approved by LBA

IV. Normal procedures

IV.1 Cockpit and control layout

Seat of Standard Astir III (Club Astir III and IIIb)

December 6, 1982

Approved by LBA

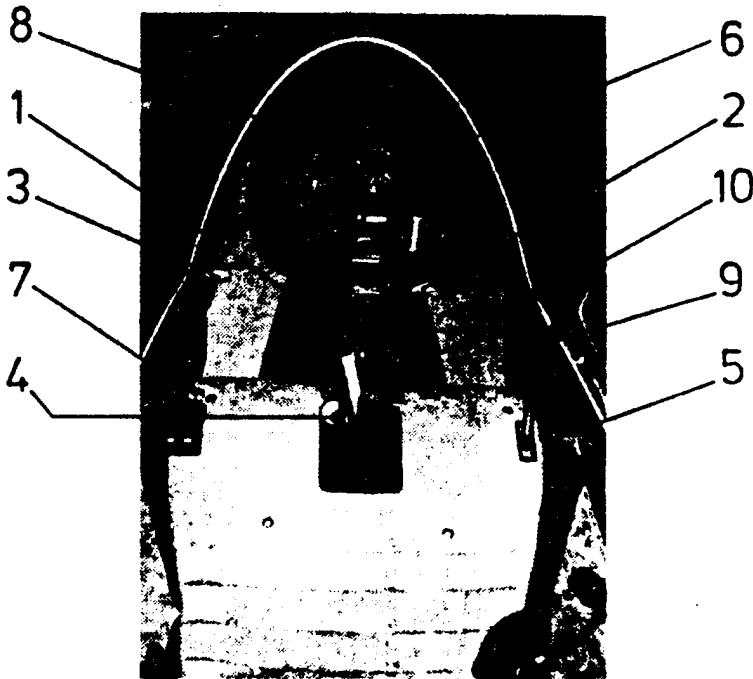

- | | |
|----------------------------|---------------------------|
| 1 Controlstick | 6 Rudder pedal adjustment |
| 2 Rudder pedals | 7 Trimhandle |
| 3 Airbrakes w. wheel brake | 8 Ventilation |
| 4 Cable release knob | 9 Undercarriage handle |
| 5 Canopy jettison | 10 Waterballast jettison |

The seatback is adjustable. (Point 9 and 10 are not valid for CLUB ASTIR III and IIIb)

Standard instrument positions

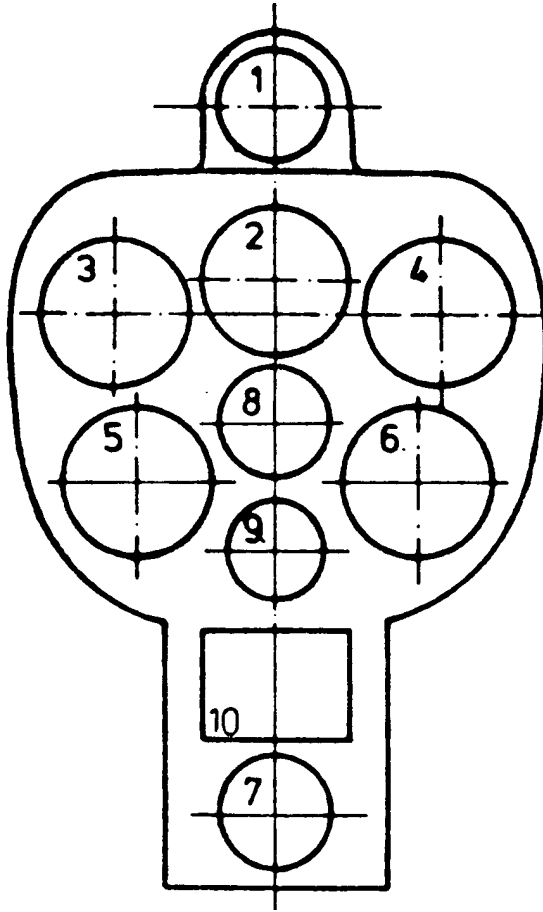

- 1 Magnetic compass
- 2 Electrical vario indicator (optional)
- 3 Airspeed indicator
- 4 Variometer
- 5 Altimeter
- 6 Electrical vario control (Optional)
- 7 G-Meter or variable
- 8 Ball
- 9 Temperature (outside) or variable
- 10 Radio

IV.2 Daily inspection

Complete check round aircraft

- I.a) Open canopy
 - b) Check the 4 wing to fuselage quick locks are secure
 - c) Visual check of all control mountings and linkages in cockpit area
 - d) Check for loose objects (also through the access door for the main control linkages)
 - e) Check full and free movement of all controls
 - f) Check tire pressure (2,5 bar = 35,6 PSI) and condition
 - g) Check condition of towhooks
 - h) Check operation of towhooks and wheelbrake
- 2.a) Check upper and lower wing surfaces for damage
 - b) Aileron (Check condition, free movement, play)
 - c) Airbrakes (Check condition, fit and lock)
- 3. Check fuselage for damage, particularly on underside
 - 4. Check tailplane for correct mounting and security
 - 5. Check tail wheel, pressure (2,5 bar 35,6 PSI) and condition
 - 6. Check pitot and venturi
 - 7. Check static holes are free of obstructions
 - 8. See "2"
 - 9. Check static holes

PAGE 24 Warning after hard landings:

"The aircraft should be checked particularly thoroughly after heavy landings or excessive demands have been placed on it in flight. Remove the wings and tailplane. If damage discovered an inspector should be called in. The aircraft should not under any circumstances be flown until the damage has been repaired."

Complete check round the aircraft (cf IV.2)

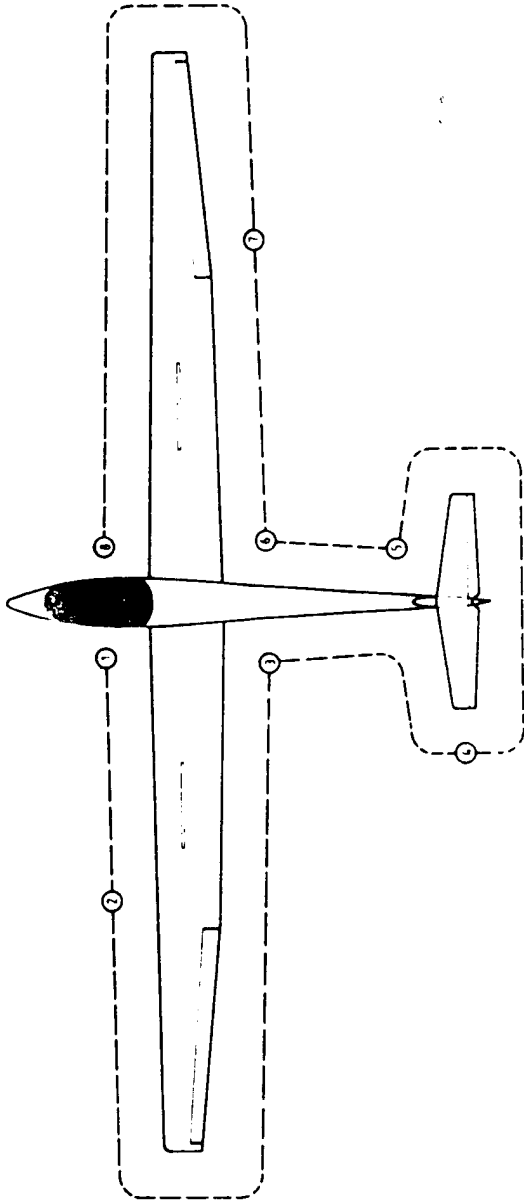

December 6, 1982

Approved by LBA

IV.3 Pre flight check

1. Wing and T-tail attachments secured?
2. Parachute and safety straps secured?
3. Pedals adjusted?
4. Undercarriage lever locked in fully forward position? (only Standard Astir III)
5. Brakes closed and locked?
6. Full and free control movement?
7. Trim set to neutral?
8. Altimeter set to zero or to field elevation?
9. Radio switched on and set to the correct base frequency?
10. Canopy locked?
11. Cable on correct hook?
12. Beware: - Crosswind - Cable break!

IV.4 Take off

Trim

The trimhandle is on the left-hand side of the cockpit and can be progressively adjusted.

Winch launch

Trim neutral or nose heavy if the pilot is light.

Maximum winch launch speed is 120 km/h (65 knots, 74 mph). The glider has a release hook in front of the wheel. Winch launches cause no difficulties at all allowed centre of gravity positions and wing loadings. The plane has no tendency to balloon up or to swing on the ground. One should push forward slightly on the stick below about 100 metres (330 ft) in the case of fast launches from a powerful winch. When the cable slackens pull the release firmly to its limit.

Aerotow launch

Recommended line length is 40 - 60 m (140- 200 ft). Trim neutral

Max aerotow speed 170 km/h (92 knots, 105 mph). Use the nose hook for aerotow if it is installed.

Aerotow from the belly hook presents no problems to experienced pilots. In this case the undercarriage of the Standard Astir III can not be retracted during the aerotow. The aircraft can be controlled during the whole ground run by means of aileron and rudder using full deflections if required. There is no tendency to ground loop, even in strong cross winds. The aircraft can be lifted off at an IAS of 65 km/h (35 kts); it takes off on its own, with the stick held neutral at an IAS of 70-74 km/h (38-40 kts). The yellow release knob is mounted on the instrument panel and must be pulled right back to release.

IV.5 Normal flight

The aircraft can be flown in all configurations throughout the permitted speed range. Full aileron and rudder movements are only permitted up to the manoeuvring speed of 170 km/h (92 knots). At higher speeds the controls are to be used with corresponding care. For the elevator movements only the g-loads 11.5 are appropriate.

December 6, 1982

Approved by LBA

IV.6 Slow flying and stalling

The stall warning is given by a noticeable buffeting of the tailplane. The stalling speed depends on the configuration and weight of the aircraft. The following standard values are appropriated to:

	Weight	Without brakes	With brakes
Without water ballast	380 kg	60 km/h	65 km/h
	838 lbs	32 kts	35 kts
With water ballast (only Standard Astir III)	450 kg	70 km/h	75 km/h
	992 lbs	38 kts	40 kts

Regard the increasing stalling speed in relation to the bank angle.

On further rearward movement of the stick the aircraft goes into a controllable "mush", which can be controlled with ailerons and rudder. On forward movement of the stick the aircraft at once returns to its normal flying attitude. A swift backward movement of the stick will produce a nose drop; the ailerons will provide lateral control.

IV. 7 High speed flight

The aircraft has no flutter problems in the permitted speed range. Above 170 km/h (92 kts) the controls must be moved no more than one third of the available movement. VNE is not exceeded in a 45 degrees dive with the airbrakes fully extended even at maximum all up weight.

December 6, 1982

Approved by LBA

IV. 8 Simple aerobatics (NOT PERMITTED IN ASA CLUB SHIPS)

Aerobatics should only be carried out by pilots who have the necessary permission. **Aerobatics may only be carried out without water ballast.**

The following aerobatics are permitted:

1. Inside loop

Entry speed	180 km/h (97 kts)
G load	ca. 2 g
Exit speed	180 km/h (97 kts)

2. Stall turn

Entry speed 180 km/h (97 kts)

At 70 knots (130 km/h) Slowly apply rudder. Shortly before the stall assist with aileron. In the case of an unintentional hammerhead stall hold the controls firmly central.

3. Spins

Reduce speed slowly to 70 km/h (38 kts): pull the stick back and give full rudder. The aircraft spins slowly at one turn every 5 seconds. The height loss is 220 ft. per turn.

Recovery: Opposite rudder, pause, stick forward till rotation stops, recover gently at about 160 km/h (86 kts).

4. Chandelle

Entry speed 150 km/h (81 kts)

Pull up to fly turn with 90 degrees bank. During turn decrease speed and exit from turn with rudder and aileron. The chandelle should be complete heading in the opposite direction at minimum speed.

5. Lazy eight

Entry speed 120 km/h (65 kts)

Manoeuvres that involve negative g loads are prohibited. Unorthodox manoeuvres are likewise prohibited.

IV. 9 Approach and landing

The approach may be carried out at 90 km/h (49 kts). The brakes are effective enough to carry out steep approaches. They cause a slight nose down trim change, so that the aircraft maintains the chosen airspeed automatically. Fully extending the airbrakes increases the stalling speed: do not extend the brakes fully during the roundout, to avoid heavy landings. During touchdown do not fully extend the airbrakes due to a very strong wheelbrake effect. The side-slip is quite controllable and, if needed this manoeuvre can be used for steeper approaches. But the side-slip is only effective by using a large angle of side-slip and should be finished at a safe height. (90 km/h; 56 mph). Rudder effect reversal have not been observed.

The temporary control force to overcome the force reversal or rudder lock is calculated approximately 2 to 5 daN (rudder pressure). The aileron does not change its force direction, rather it returns independently from the full deflected position. Rudder lock can be relieved without pilot input on the rudder. After moving the aileron into neutral position, the Sailplane rolls out of the Slip into wing level position. Thereafter the rudder frees itself from the full deflected position and the force reversal is relieved. Using this method to end the Slip no bucking of forward pitching is evident. During roll out the Sailplane deviates only slightly from its original flight course. This leveling out manoeuvre takes only a few seconds.

December 6, 1982

Approved by LBA

IV.-IO Flight with water ballast (ONLY STANDARD ASTIR III)

A flight with maximum pay-load and additionally full amount of water ballast is comparable with a standard two-seat glider. Therefore the flight characteristics of slow flying and stalling are different with water ballast flights to flights without water ballast. The stalling speed increases to about 70 km/h (38 kts). Greater control deflection are needed to correct the attitude. The entry to the spin is more abrupt than without water ballast, but it will be recovered by the standard procedure immediately. Slow flying and stalling with maximum gross weight should be practised at a safe height.

The water ballast tanks are located in the wings and contain approximately 45 litres pier wing. They are filled through the plugs on the top surface of the wings, which can be removed with a rod.

Built in baffles ensure that no noticeable movement of the water occurs in flight, when the tanks are partially filled.

The water has to be poured in and not filled in under the pressure of the water-pipe. Equal amounts of water must be put in each tank to make up the required amount, so that lateral stability is not impaired.

Water ballast is dumped through an opening under the fuselage behind the wheel-box. The valve is opened by pulling and turning the black knob at the right side of the instrument panel. Dumping of full water ballast takes about 3 minutes

Air from the tanks escapes through an overflow pipe that runs down to the cleft of aileron.

December 6, 1982

Approved by LBA

When flying with water ballast the adhesive tape that covers the 'gap between fuselage and wings, should not cover the gap on the underside in the region of the spar, so that leaking water which may appear cannot run down into the fuselage. Before longer flights at temperatures around 0°C (32°F) the water must be jettisoned because of the danger of freezing. It is strongly recommended that water ballast is jettisoned before landing,

The glider has to be parked over-night without water ballast due to the danger of freezing. When derigging the water ballast tanks will empty themselves through the wing root connecting pipes. If the glider has to be towed for a long way on a bumpy ground, the water tanks should be emptied to take care of the wing suspensions.

IV.11 Storage

When the glider is stored the canopy should be locked. To tie down the wing, a rope can be pulled through the wing tip skids.

December 6. 1982

Approved by LBA

V. Performance

All up weight	<u>380 (838)</u>	<u>450 (992)</u>	kg(lbs)
Wing loading	30,6(6,3)	36,3(7,4)	kg/m ² (lbs/sq.ft)

Best glide angle	36	38,0	
at flying speed	92 (50)	105 (57)	km/h (kts)
Minimum sink	0.62(122)	0.7 (138)	m/sec (ft/min)
at flying speed	76 (41)	85 (46)	km/h (kts)

December 6, 1982

Approved by LBA

V.I.

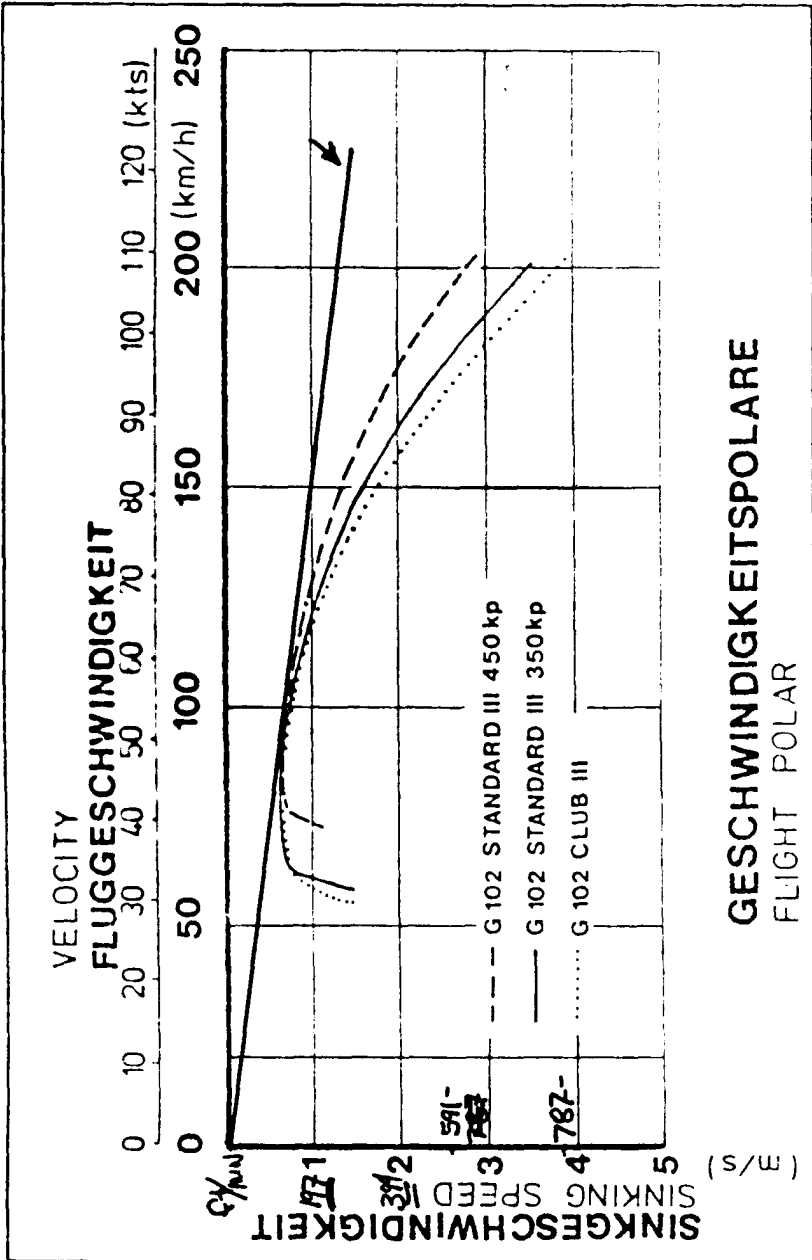

$4 \text{ m/s} = 39.37 \text{ "/s}$

December 6, 1982

Approved by LBA

VI. Rigging and derigging

VI.1. Rigging

The fuselage must be held firmly in an upright position when rigging. It is recommended that a fuselage stand or the trailer fittings are used. The glider can be rigged by 3 people.

1. Wings

Unlock the 4 main wing fittings in the fuselage (a). Unlock the airbrakes on the wings. Guide the right wing into the fuselage. The safety catches on the fuselage fittings should now be released and on gently moving the wing to and fro will be heard to snap into place (b). Next guide the left wing into the fuselage. Move the wings tips up or down so that the pin on the end of the spar stub is lined up with the appropriate hole in the opposite wing root and slide into place. Next release the safety catches on the left fuselage fittings and by gently moving the wing tip forwards and backwards they too can be made to snap into place (b).

To lock the fuselage fittings turn so that the pins are engaged in the slots. A slow but firm fore and aft movement of the wing tip will allow the collar to be turned sufficiently. They should not however reach the end of the slot (c).

Check - The red rings on the fuselage sides must be covered by the rotating collars. The collars should be finger tight.

In the closed but not secured position (b) the wings cannot be withdrawn.

2. The aileron and airbrake connections are behind the spar

The connecting rods can be connected by means of the quick lock fasteners through the inspection cover. If necessary the aileron has to be moved tip and down to get the linkages into the right position.

October '1962

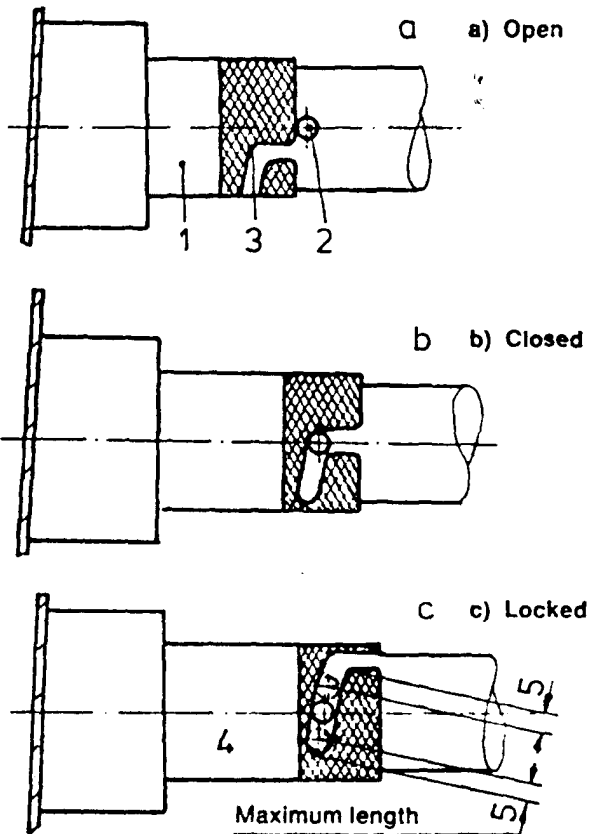

After rigging the following check must be carried out to check the connections are secure:

After connecting the quick lock couplings make a visual check that the collar is extended forward over the bearing far enough for the safety pin to engage.

October 1982

Having engaged the quick locks check that the safety pin cannot be moved without pressing it down. If it cannot be slid without pressing down the controls are properly connected.

3. Tailplane

Before assembly is commenced the front cover must be opened and the rotating wing bolt pulled out to the limit. It is important to ensure, that the larger opening of the conical crillings in the inner rings of the horizontal stabilizer spar bearings fall to the rear. The tailplane can best be positioned by standing behind the rudder. The tailplane can be rested on top of the fin with the elevator angled upwards so that the quick lock on the elevator push rod can be attached to the bearing on the elevator horn. The front of the tailplane can then be pushed back on to the three pins. It is then necessary to tighten the wing bolt clockwise to secure the tailplane. The assembly is complete when the wing bolt is sufficiently tight for there to be no play in any direction. The cover provides a safety measure as it can only be attached with the wing bolt horizontal. If necessary the wing bolt has to be turned a quarter turn to suit. Derigging is carried out in the opposite order and the wing bolt is unscrewed anticlockwise and pulled fully out.

To control the correct mounting of the horizontal stabilizer it is important to ensure that the peaks of the mark-arrows at fin and elevator tabs face each other.

Checks to be made after rigging.

- 1 Check that the four collars in the fuselage are engaged and secure.
- 2 Check that the aileron, airbrake and flap connections are engaged.
- 3 Check the towhooks for correct function and operating forces
- 4 Test the operation of the wheel brake and the tire pressure.
- 5 Check that the tailplane is securely seated, control the 4 markings.
6. Check the elevator is coupled correctly through the clear panel.
7. Check sense and full and free movement of controls with an observer.

VI.2. Derigging

Derigging is carried out in the reverse order and in this case it does not matter which wing is removed first. Excessive fore and aft rocking of the wingtips should be avoided.

October 1982

VI. 3 Transport

We recommend the use of a closed trailer for transporting the glider. The parts must be carefully supported and secured so they cannot slide.

1. Fuselage

A fuselage trolley molded to the shape of the fuselage and positioned in front of the main wheel. The minimum length of the trolley should be 400 mm and it can be attached to the wing fittings if required. The tail skid should be secured so that it cannot slide sideways.

(400 mm = 16 in.)

2. Wings

The minimum length for the spar support should be 200 mm and should start at the face of the root rib. The mounting must be padded well with foam rubber or felt.

The mounting under the aileron inboard end should be a shaped mounting block with a minimum length of 300 mm and height of 400 mm. The mounting must be padded with felt.

(200 mm = 8 in.; 300 mm = 12 in.)

3. Tailplane

Either horizontal on padded supports with the upper surface downwards and secured with straps or vertical supported on the leading edge in shaped mounting blocks.

Profile drawings are available for the manufacture of fuselage, wing and tailplane fittings.

VI.4. Simple Maintenance

The entire surface of the glider is coated with weather resistant white polyester gelcoat.

The greatest care should be taken in maintaining the fibre glass surface of the glider. Luke worm water should be used to wash off dust, grease, dead flies and other dirty marks. More resistant dirt should be removed by using a mild cleaning agent. Only special sili- preparations should be used in maintaining the painted surfaces. (I Z-Spezialreiniger - D 2, Fa. W. Sauer and Co., 5060 Densberg or Reinigungspolish Fa. Lesonal),

October 1982

Although very resistant the glider should be protected as much as possible against rain and dampness. Water that has seeped in should be dealt with by storing the glider in a dry place, frequently turning over the dismantled parts.

The most effective way to clean the canopy is to use a special perspex cleaner but if necessary luke warm water can be used. A soft, clean cloth or chamois-leather should be employed to wipe the canopy down. Never rub perspex with anything dry.

The Safety harness should be regularly checked for damage and general wear. The metal parts of the harness should be frequently checked for corrosion.

Because of its position, the winch launch hook is susceptible to getting very grimy and muddy. It must therefore be frequently inspected for damage, cleaned and greased. When the seatwell is removed the hook can easily be taken out. Remove the connecting wire from the lever and take out the retaining screws. For reconditioning. the tow hook should be sent with the record card to the tow hook manufac- Tost For further details the manufacturers manuals should be consulted

The cables and pulley for the nose and belly hooks should be checked for wear during the yearly inspection. The wheels tyre pressure should be kept at 3,5 amospheres 2,5 bar (36 psi).

Before assembling the glider the pins and sockets at the joints between wings and fuselage, and tailplane and fuselage, should be cleaned and greased.

October 1982

VI I . Measurement of centre of gravity

The determination of the center of gravity is made with the undercarriage extended and the glider supported on two scales in such a way that an incidence board of 600 : 26 angle is set horizontal on the back of the fuselage. The reference plane is situated at the front of the wing at the root. The distances a and b measured with the help of a plumb line The empty weight is the sum of the two weights G1 and G 2

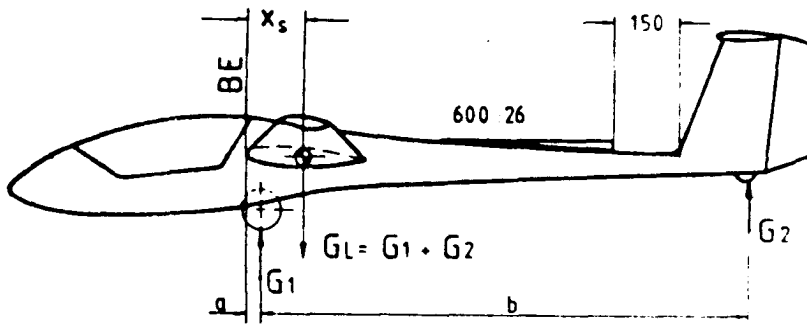

Datum line: Front edge of the wing at the root rib (BE)

Level means: With a 600 : 26 incidence board set up horizontal on the top of the rear fuselage.

Weight on main-wheel

G1 kg 'lbs

Weight on tail-skid

G2 kg, lbs

Empty Weight G_L

$G_1 + G_2$ kg . lbs

Distance to main-wheel

a mm 'inches

Distance to tail-skid

b mm 'inches

Empty weight C. of G.

$$X = \frac{G_2 \times b}{G_L} + a = \underline{\hspace{2cm}}$$

mm/inches behind datum line

The measurements to determine the empty weight, the empty weight C of G and the loading limitations must always be taken with the glider empty of water ballast and without removable ballast weights.

Conversion	from	to	multiply with
	kg	lbs	2.2
	mm	Inches	0.0394

1.

If the limits of the empty weight C of G positions and the loading limitations chart are adhered to, the C of G of the loaded glider will be within the permitted range.

STANDARD and CLUB ASTIR III

Empty Weight kg	Range of C. of G. behind Datum (mm)	
	<u>Forward</u>	<u>Aft</u>
250	702	769
255	693	763
260	685	758
265	677	753
270	670	748
275	648	743
Z80	626	738

It should be noted that to make use of the maximum load the minimum admissible load for non lifting parts must not be exceeded

The weight of the non lifting parts is the sum of the fuselage, tailplane, and maximum load in the fuselage and must not exceed 250 kg (551 lbs) or the maximum load permitted in the fuselage must be correspondingly decreased. This refers to the load of the fuselage.

The Centre of Gravity should be rechecked after repair, repainting, the installation of additional equipment or when a period of 4 years has elapsed from the time of last weighing.

October 1982

The empty weight, empty weight C of G position and the maximum load should be recorded after each weighing on page 11 of the Flight Manual.

To find out the Center of Gravity of the loaded sailplane:

- C. of G. of the pilot is located 552 mm in front of the datum line
- C. of G. of the water ballast is located 276 mm behind the datum line.

October 1982